

# PARCAN

## PARCAN

The classic and functional form of ParCans has been established in the Rock'n'Roll world. Kupo offers a wide range of ParCans, that are different in sizes (64, 56, 46, 36, 30, 20, 16, 11) and nose (short/long), bracket form, thickness of the material and lamp socket, color (black & polish) etc. Kupo ParCan is manufactured from high quality spun aluminum.

The standard features of Kupo ParCan are:

1. made from 1.5mm thick aluminum
2. supplied with an octagonal or square color frame
3. 4th hinge spring clip
4. yoke lock washer
5. safety wire
6. 32mm wide yoke
7. cable gland
8. rolled lip on focus hole
9. TUV/UL version is available when specified on the order

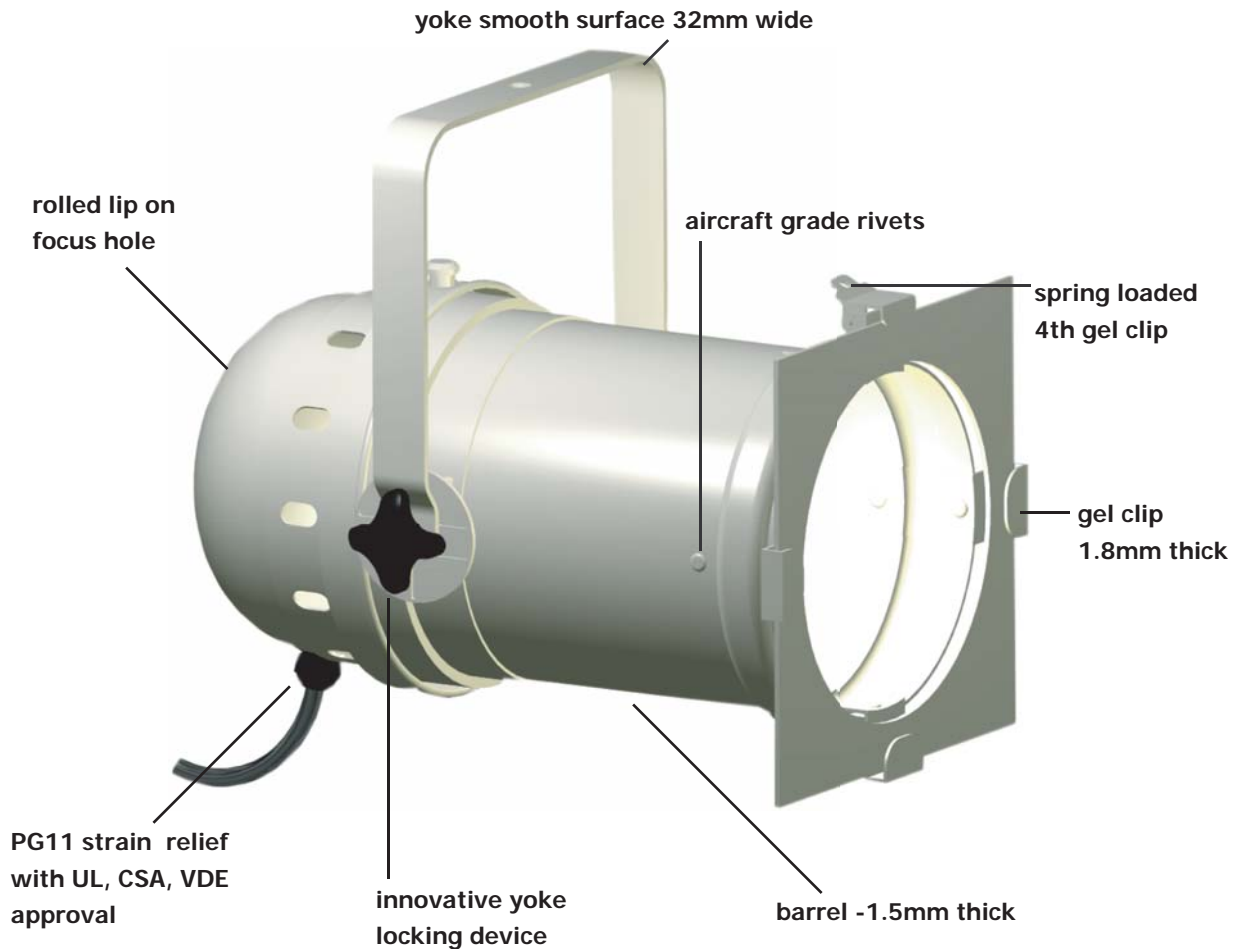

**PAR64 LONG NOSE VERSION**

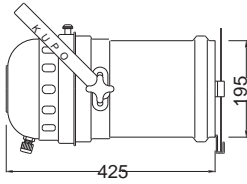

**PAR-64LB** long nose, black  
**PAR-64LP** long nose, polish

**PAR56 LONG NOSE VERSION**

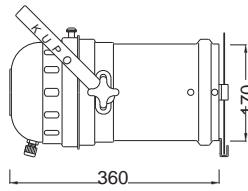

**PAR-56LB** long nose, black  
**PAR-56LP** long nose, polish

**PAR46 LONG NOSE VERSION**

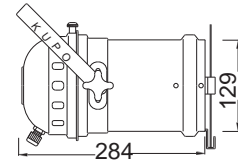

**PAR-46LB** long nose, black  
**PAR-46LP** long nose, polish

**PAR64 SHORT NOSE VERSION**

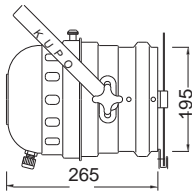

**PAR-64SB** short nose, black  
**PAR-64SP** short nose, polish

**PAR56 SHORT NOSE VERSION**

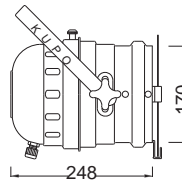

**PAR-56SB** short nose, black  
**PAR-56SP** short nose, polish

**PAR46 LONG NOSE W/E27**

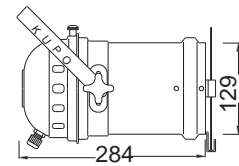

**PAR-46LB/E27** long nose, w/E27 socket, black  
**PAR-46LP/E27** long nose, w/E27 socket, polish

**PAR64 FLOOR SPOT VERSION**

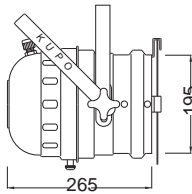

**PAR-64FB** floor can, black  
**PAR-64FP** floor can, polish

**PAR56 ECONOMIC VERSION**

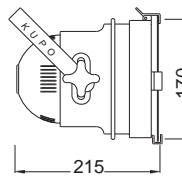

**PAR-56XSB** short, black  
**PAR-56XSP** short, polish

**PAR46 SHORT NOSE VERSION**

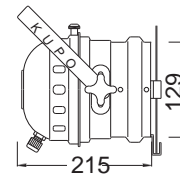

**PAR-46SB** short nose, black  
**PAR-46SP** short nose, polish

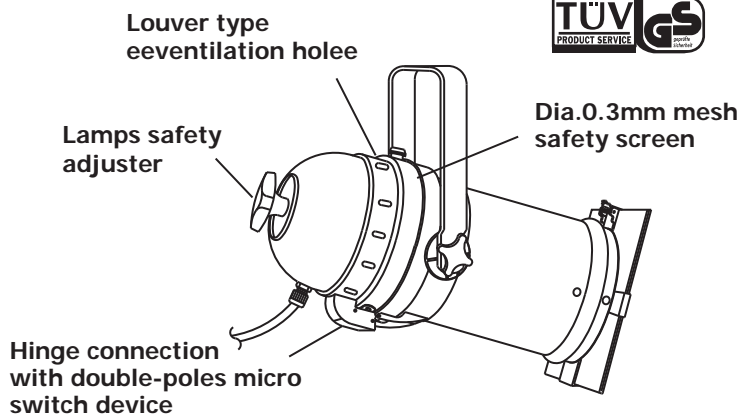

**PAR 64 with TUV approval (EN60598-2-17)**

**PAR 64 color changer lantern**  
 Par 64 with a support arm for the added weight of a color changer, available in black or silver finish.

**PAR-64CB, P**

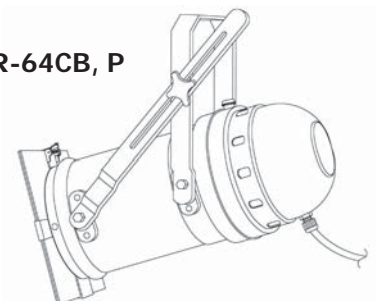

**PAR46 SHORT NOSE W/E27**

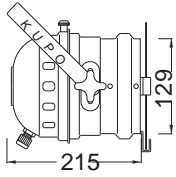

**PAR-46SB/E27** short nose, w/E27 socket, black  
**PAR-46SP/E27** short nose, w/E27 socket, polish

**PAR20 LONG NOSE VERSION**

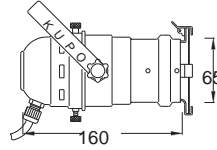

**PAR-20LB** long nose, black  
**PAR-20LP** long nose, polish

**PAR16 LONG NOSE VERSION**

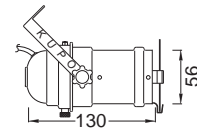

**PAR-16LB** long nose, black  
**PAR-16LP** long nose, polish

**PAR36 LONG NOSE VERSION**

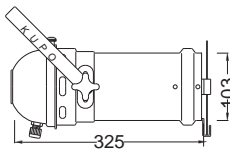

**PAR-36LB** long nose, black  
**PAR-36LP** long nose, polish

**PAR20 LONG NOSE W/GZ10**

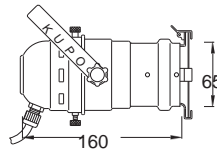

**PAR-20LB/GZ10** long nose, w/ GZ10 socket, black  
**PAR-20LP/GZ10** long nose, w/ GZ10 socket, polish

**PAR16 LONG NOSE W/GZ10**

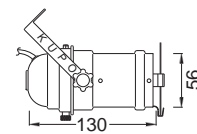

**PAR-16LB/GZ10** long nose, w/GZ10 socket, black  
**PAR-16LP/GZ10** long nose, w/GZ10 socket, polish

**PAR36 SHORT NOSE VERSION**

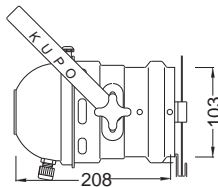

**PAR-36SB** short nose, black  
**PAR-36SP** short nose, polish

**PAR20 SHORT NOSE VERSION**

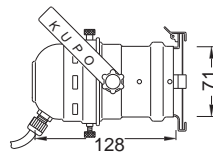

**PAR-20SB** short nose, black  
**PAR-20SP** short nose, polish

**PAR16 SHORT NOSE VERSION**

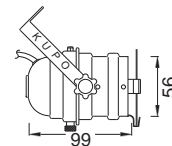

**PAR-16SB** short nose, black  
**PAR-16SP** short nose, polish

**PAR30 LONG NOSE VERSION**

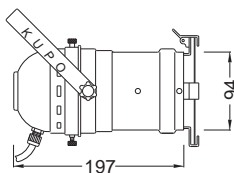

**PAR-30LB** long nose, black  
**PAR-30LP** long nose, polish

**PAR20 SHORT NOSE W/GZ10**

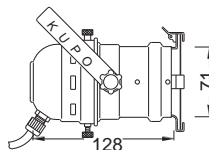

**PAR-20SB/GZ10** short nose, w/ GZ10 socket, black  
**PAR-20SP/GZ10** short nose, w/ GZ10 socket, polish

**PAR16 SHORT NOSE W/GZ10**

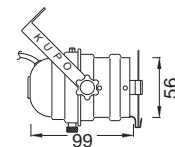

**PAR-16SB/GZ10** short nose, w/GZ10 socket, black  
**PAR-16SP/GZ10** short nose, w/GZ10 socket, polish

**PAR11 SHORT NOSE VERSION**

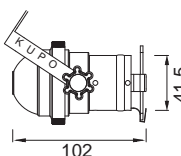

**PAR-11SB** short nose, black  
**PAR-11SP** short nose, polish

Note. PAR-20 w/GZ10 socket, recommend lamp: 230V/75W; Sylvania Hi-Spot/ES63  
Note. PAR-16 w/GZ10 socket, recommend lamp: 230V/50W; Sylvania Hi-Spot/ES63

## OPTIONAL ACCESSORIES

### 1. REFLECTOR FOR PAR64

Kupo's TRI-R6M is designed for PAR64 Cans. The innovative reflector, lens and socket combination delivers better light output than conventional 1000W PAR64 lamps. Spot field gets much smoother even light. Just snap different lens at the front of the reflector to change the beam shape.

- A. Lightweight, sturdy aluminum spun construction, with anodizing coating reflector. Good cooling system
- B. UL approval G9.5 Medium Two Pin Aluminum cooling lamp holder accepts wide variety of non-proprietary lamps
- C. Wiring system is available for Mogul socket for conventional EMEP socket
- D. Each reflector included with three kinds of lens to change the beam shape of very narrow, medium narrow and medium flood
- E. It can be installed into the conventional PAR64
- F. Tool free easily to replace lamp from rear side

**R6-NSP** Lens for TRI-R6M narrow spot

**R6-VNSP** Lens for TRI-R6M very narrow spot

**R6-MFL** Lens for TRI-R6M medium flood spot



TRI-R6M narrow spot

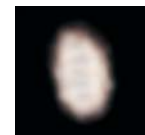

Standard PAR64 narrow spot

**Recommend lamp:**

G9.5 base FEL(CP77) 120v/100w 375 life hours.

G9.5 base FEP(CP77) 230v/1000w 300 life hours.

### 2. 4-LEAF BARNDOOR FOR PARCAN

Lightweight, compact size, foldable blade & adjustable direction four-leaf barndoor available for whole ParCan series. Standard is black finish. Other finishes are available.

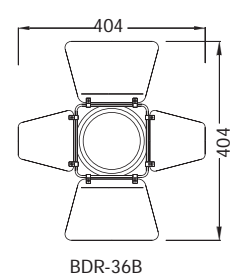
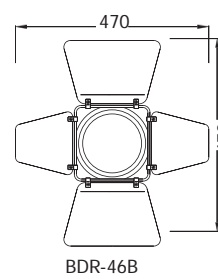
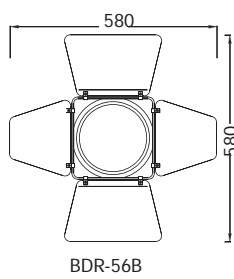
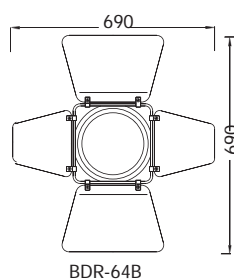

Item	ø (mm)	A	B	C
BDR64		218	239	262
BDR56		188	210	228
BDR46		152	174	186
BDR36		121	142	169
BDR30		100	127	143
BDR20		56	79	88
BDR16		51	73	83

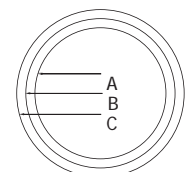
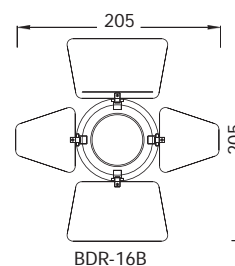
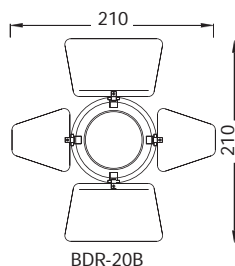
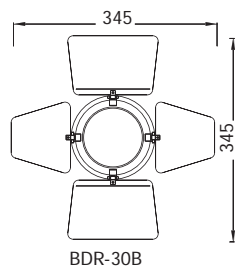

\* Prior to purchasing barndoor, please notice the discrepancy as Par Can dimension might vary by different suppliers.

### 3. PARSAFE FOR PAR64/56

KUPO Parsafe is with high temperature resistance, which offers great benefits to cans.

#### PS-64 PARSAFE

- A. Be used at PAR64/56
- B. Make lamp rotating operation safe when lamp is on
- C. Double electric insulation (excluding socket)



### 4. SOCKET FOR PARCAN

#### ES-01

EMEP socket for PAR64/56

#### ES-01SC

EMEP socket with 72cm silicon cable

#### ES-02

Top off ceramic socket for PAR64/56



ES-01

ES-01SC

ES-02

### 5. RAYLIGHT REFLECTOR FOR PARCAN

Raylight for PAR64, 56, 46 anodized finish. Available in trailing lead and mogul socket types.

#### RF-64

Raylight reflector for PAR64, trailing lead type

#### RF-64M

Raylight reflector for PAR64, w/ mogul socket type

#### RF-56

Raylight reflector for PAR56, trailing lead type

#### RD-56M

Raylight reflector for PAR56, w/ mogul socket type

#### RF-46

Raylight reflector for PAR46, trailing lead type

#### RF-46M

Raylight reflector for PAR46, w/ mogul socket type



RF-64M

RF-56M

RF-46M

RF-64

RF-56

RF-46

### 6. ADJUSTER

#### ADJ-64B

Safety lamp adjuster for PAR64

#### BP-64B

Blanking plate for PAR64



ADJ-64

BP-64