

PAR64 LONG NOSE VERSION

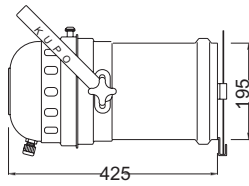

PAR-64LB long nose, black
PAR-64LP long nose, polish

PAR56 LONG NOSE VERSION

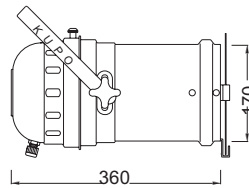

PAR-56LB long nose, black
PAR-56LP long nose, polish

PAR46 LONG NOSE VERSION

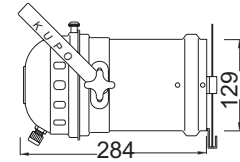

PAR-46LB long nose, black
PAR-46LP long nose, polish

PAR64 SHORT NOSE VERSION



PAR-64SB short nose, black
PAR-64SP short nose, polish

PAR56 SHORT NOSE VERSION

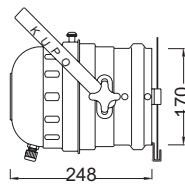

PAR-56SB short nose, black
PAR-56SP short nose, polish

PAR46 LONG NOSE W/E27

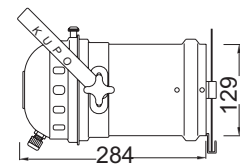

PAR-46LB/E27 long nose, w/E27 socket, black
PAR-46LP/E27 long nose, w/E27 socket, polish

PAR64 FLOOR SPOT VERSION

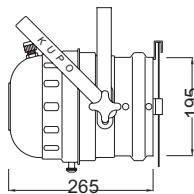

PAR-64FB floor can, black
PAR-64FP floor can, polish

PAR56 ECONOMIC VERSION

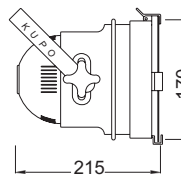

PAR-56XSB short, black
PAR-56XSP short, polish

PAR46 SHORT NOSE VERSION

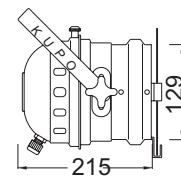

PAR-46SB short nose, black
PAR-46SP short nose, polish

Louver type
 eeventilation holee



Lamps safety
 adjuster

Dia.0.3mm mesh
 safety screen

Hinge connection
 with double-poles micro
 switch device

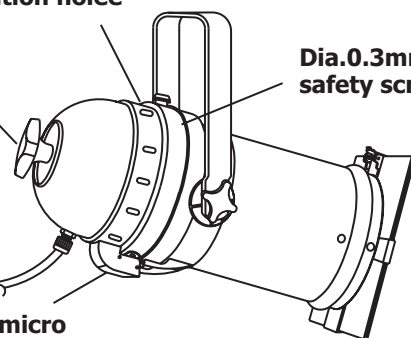

PAR 64 with TUV approval (EN60598-2-17)

PAR46 SHORT NOSE W/E27

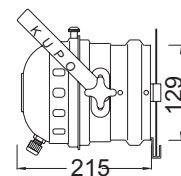

PAR-46SB/E27 short nose, w/E27 socket, black
PAR-46SP/E27 short nose, w/E27 socket, polish